



## Semi Automatic Farming

---

Raghava Sai Murthy Puppala, Venkateswarlu Alapati,  
Naga Bharadwaj Purighella, Sri Charan Sanagala and  
Gaurav S Kumar

EasyChair preprints are intended for rapid dissemination of research results and are integrated with the rest of EasyChair.

February 23, 2022

# Semi-Automatic Farming

P Raghava Sai Murthy<sup>1</sup>, A Venkateswarlu<sup>2</sup>, P Naga Bharadwaj<sup>1</sup>, S Sri Charan<sup>1</sup> and Gaurav S Kumar<sup>1</sup>

<sup>1</sup> Student, Mechanical Engineering Department, V R Siddhartha Engineering College, Vijayawada, India

<sup>2</sup> Professor, Mechanical Engineering Department, V R Siddhartha Engineering College, Vijayawada, India

E-mail: [raghavasaimurthy@gmail.com](mailto:raghavasaimurthy@gmail.com)

**Abstract.** In India most of the population are practising agriculture as their livelihood and can never be underestimated. Although its contribution in the gross domestic product (GDP) has reduced to less than 20 per cent and contribution of other sectors increased at a faster rate, agricultural production has grown. This made India the rice bowl of the world and it is one of the greatest exporters of farm products. Increasing population, increasing average income and globalisation effects in India will increase demand for quantity, quality and nutritious food, and variety of food. Farmers in India are giving up the farming field because there are no more profits in this field and there are lot of risk factors included. Farmers are still not able to earn respectable earnings. Future of agriculture is a very important topic to be looked up to. Government and other organisations are trying to increase interest towards this sector by introducing some new schemes and policies. So, for the improvement of agriculture in the future, we introduce this project where we automate the process of farming which includes ploughing, sowing, spraying pesticides, irrigation, harvesting by introducing a monorail setup which is powered by means of an electric source. The movement of head on the track would be remote controlled.

**Keywords:** Agriculture, Monorail setup, Remote control, CAD, Ansys, Load and Material analysis, Automated Process, Prototype

## 1. INTRODUCTION

The present generation is showing less interest towards agriculture as farmers are practicing traditional methods for cultivation in which there is less profit with high investment which includes increased charges for waged labourers.

Increasing population, increasing average income and globalisation effects in the world will increase demand for quantity, quality and nutritious food, and variety of food. Therefore, pressure on decreasing available cultivable land to produce more quantity, variety and quality of food will keep on increasing. Hence innovative and helpful methods of farming for effective outcome is required.

Farm workers and pesticide applicators are also more vulnerable because they receive greater exposures. Pesticides are poisonous and, unfortunately, they can harm

more than just the “pests” at which they are targeted. They are toxic, and human exposure to pesticides can cause a number of health effects.

The world is being updated in so many different aspects but in agriculture, the improvement is not up to the mark. Various new technologies are being developed and some are already being used in developing the society. Even though researches are being done which concentrates on agriculture, not much of a development is being seen.

## 2. PROJECT DESCRIPTION

### 2.1 CONSTRUCTION

It consists of a rail, on which the main component of our project which is similar to a wagon moves. A high-powered diesel engine is used for actuation of the wagon. The wagon accommodates tool for ploughing, sowing, spraying pesticides and irrigation. The whole

system is set up on a field. The rail is set up according to the size of the field.

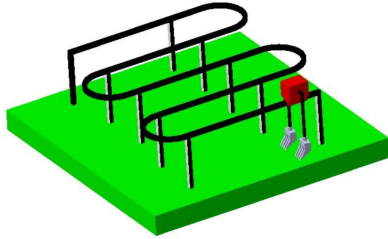

*Monorail setup*

Different tools attachable to the arms of the wagon include:

**2.1.1 Ploughing tool:**

It is the tool which is used to plough the ground. It is 3m long and has hook on its head to mount to the arm. It is designed using NX CAD 11.

**2.1.2 Sowing tool:**

It is the tool which is used to sow the seeds on the plot. It is 3m long and has hook on its head to mount to the arm. It is designed using NX CAD 11.

**2.1.3 Irrigation:**

A tube and sprinklers setup are fixed all over the columns of the structure. It is designed using NX CAD 11.

**2.1.4 Pesticide Sprayer:**

It has same setup as that of irrigation system but water is replaced in place of pesticides. It is designed using NX CAD 11.

**2.1.5 Harvesting tool:**

It is a tool to cut the final crop and carry it in the tray. It is designed using NX CAD 11.

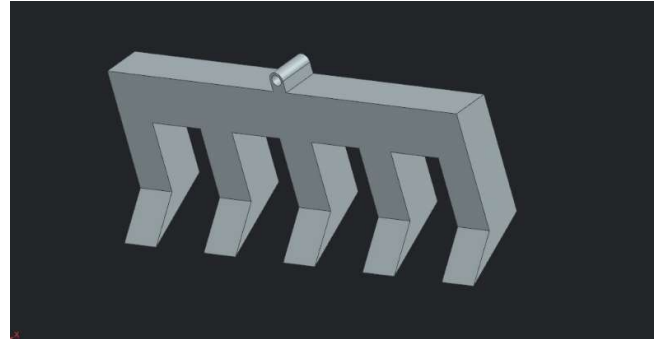

*PLOUGHING TOOL*

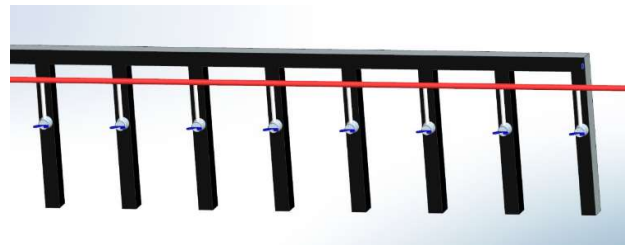

*IRRIGATION SETUP*



*PESTICIDES SPRAYING SETUP*



*SOWING TOOL*

some similar applications. This analysis has been performed using ANSYS R22.

Material 1: Cast Iron  
 Length of the specimen: 1000 mm  
 Diameter of the specimen: 120 mm  
 Young's Modulus: 110 GPa  
 Deflection: 0.709 mm

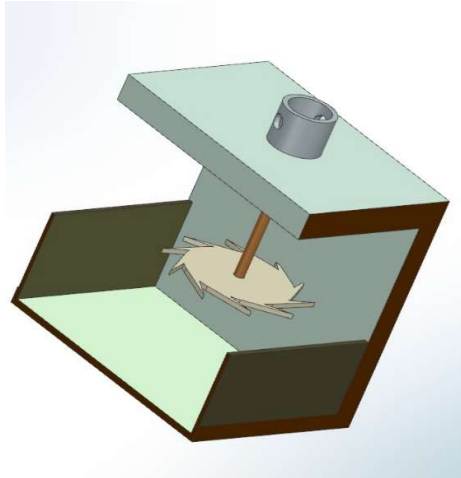

HARVESTING TOOL

```
PRNSOL Command
File
-----
PRINT U      NODAL SOLUTION PER NODE
***** POST1 NODAL DEGREE OF FREEDOM LISTING *****
LOAD STEP= 1 SUBSTEP= 1
TIME= 1.0000 LOAD CASE= 0
THE FOLLOWING DEGREE OF FREEDOM RESULTS ARE IN THE GLOBAL COORDINATE SYSTEM
      NODE      UY
      1      0.0000
      2     -0.70950
MAXIMUM ABSOLUTE VALUES
NODE      2
VALUE     -0.70950
```

Figure 1

## 2.2 WORKING

- Firstly, we should measure the area of land available for farming. Depending upon the measured area, we should design the rail pattern and the vertical supports.
- Based on the process to be performed, the corresponding tool is selected and attached to the wagon arms.
- Different processes include ploughing, sowing, irrigation, spraying pesticides and harvesting.
- Power required for the wagon movement is provided and is controlled with the help of a remote control.

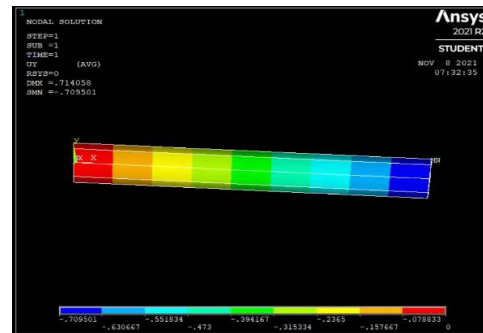

Figure 2

## 3. MATERIAL, METHOD AND ANALYSIS

### 3.1 MATERIAL SELECTION

We have done analysis by applying loads on some materials like Cast Iron, Corten steel, Aluminium and Mild steel which were used in

Material 2: Weathering steel or Corten steel  
 Length of the specimen: 1000 mm  
 Diameter of the specimen: 120 mm  
 Young's Modulus: 190 GPa  
 Deflection: 0.410 mm

```
PRNSOL Command
File
-----
PRINT U      NODAL SOLUTION PER NODE
***** POST1 NODAL DEGREE OF FREEDOM LISTING *****
LOAD STEP= 1 SUBSTEP= 1
TIME= 1.0000 LOAD CASE= 0
THE FOLLOWING DEGREE OF FREEDOM RESULTS ARE IN THE GLOBAL COORDINATE SYSTEM
      NODE      UX      UY      UZ      USUM
      1      0.0000      0.0000      0.0000      0.0000
      2      0.0000     -0.41076      0.0000      0.41076
MAXIMUM ABSOLUTE VALUES
NODE      2
VALUE      0.0000     -0.41076      0.0000      0.41076
```

Figure 3

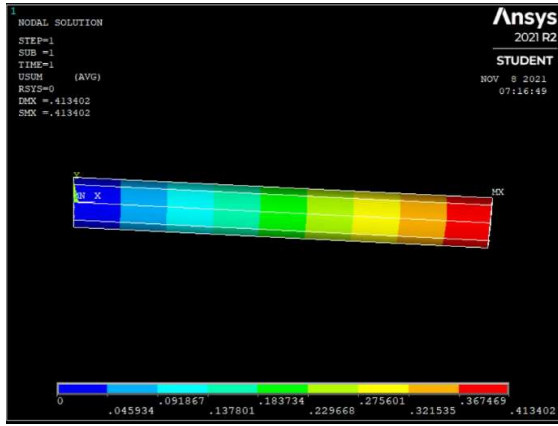

Figure 4

Material 4: Mild Steel  
 Length of specimen: 1000 mm  
 Diameter of the specimen: 70 mm  
 Young's Modulus: 230 GPa  
 Deflection: 3.35 mm

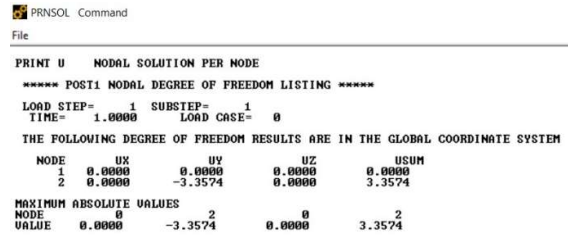

Figure 7

Material 3: Aluminium  
 Length of the specimen: 1000 mm  
 Diameter of the specimen: 120 mm  
 Young's Modulus: 69 GPa  
 Deflection: 1.131 mm

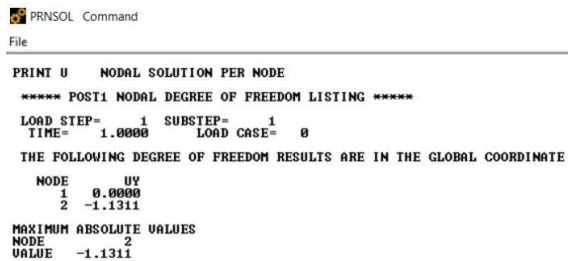

Figure 5

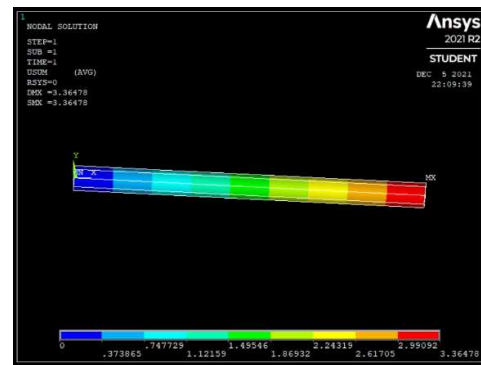

Figure 8

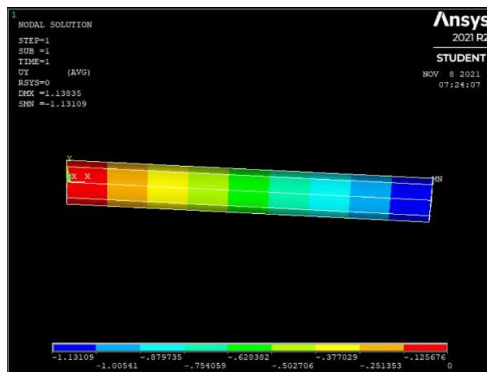

Figure 6

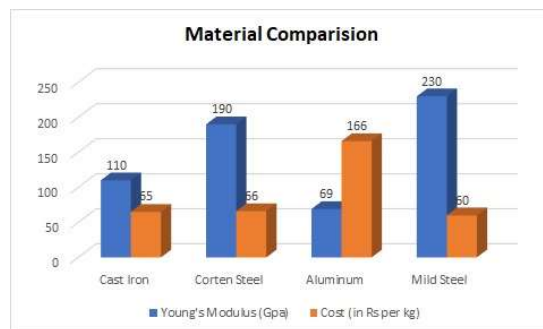

Figure 9

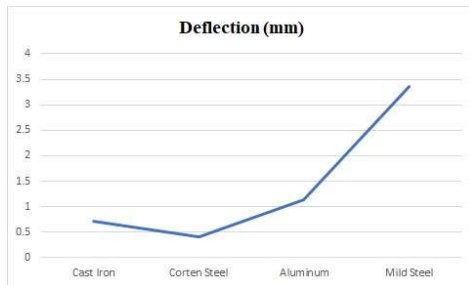

Figure 10

From the above comparison it is clear that **Mild Steel** is the suitable material of choice for our design.

### 3.2 FIELD ANALYSIS

- Area of the plot: 1 acre = 4047 square meter
- Dimensions: 92 m X 44 m
- Track
  - Material: Mild Steel
  - Dimensions: 90 m X 0.06 m X 0.06 m
  - Thickness: 0.01 m
  - Number of rows: 11
  - Distance between two rows: 4 m

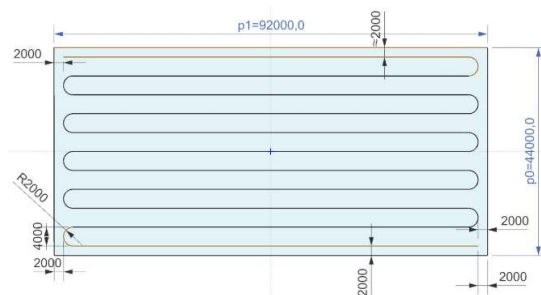

Figure 11

All dimensions are in mm

- Column
  - Material: Mild Steel
  - Dimensions: 60 mm diameter, 1.5 m length
  - Number of columns per row: 9

- Total number of columns per acre:  $9 \times 11 = 99$
- Distance between two columns: 11.25 m (37 feet)

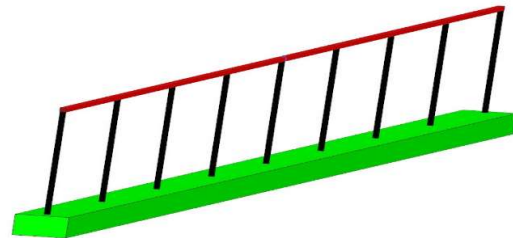

Figure 12

### 3.3 LOAD ANALYSIS

- Ploughing tool
  - Mass: 270 kg
  - Length of tool: 2 m
- Arm
  - Material: Mild Steel
  - Mass: 75.5 kg
  - Cross section: Circular
  - Dimension: 0.07 m diameter
- Battery
  - Type: LiFePO4
  - Voltage: 12.8V, 100 Ah
  - Mass: 11kg
  - Applications: Electric vehicles, Heavy machinery handling in constructions.
- Motor
  - BG series helical gear motor
  - Output: 75 kW
  - Mass: 30kg

## 4. RESULTS

- Simulation is done and link is provided below.  
<https://drive.google.com/file/d/119glbSIpnHJRWCpiF-NcfwdbFsaMFzvt/view?usp=sharing>
- Prototype is made.



applied to the crop by checking the atmospheric conditions.

The agricultural progress has been a crucial factor in worldwide social and economic change. In the traditional methods human labour will provides the weather and land condition, according the condition discussion will be taken.

The techniques already in use are:

**i. Spraying pesticides using drones:**

D. J. Mulla, "Twenty-five years of remote sensing in precision agriculture: Key advances and remaining knowledge gaps", *Biosyst. Eng.*, vol. 114, pp. 358-371, Apr. 2013

**ii. Cultivation using IOT:**

Pamidi Srinivasulu, R Venkat, M. Sarath Babu and K Rajesh, "Cloud Service Oriented Architecture (CSoA) for agriculture through Internet of Things (IoT) and Big Data", 2017 International Conference on Electrical Instrumentation and Communication Engineering (ICEICE2017)

**iii. Sowing seeds using drone:**

Sunil Karbharee Diwate, "Design and Development of Application Specific Drone Machine for Seed Sowing", *DYPSOEA Ambi*, 2018.



**5. EXISTING METHODS**

Until now several methods have been developed for practicing different agricultural processes. Different sensors are used like Temperature Sensor, Humidity Sensor and Soil Moisture Sensor for the field data and central server for the data processing. Agriculture has played a major role in human history; human developed different methods for the development of crops, these methods are

**6. ADVANTAGES**

- Unmanned farming can be done using this method of farming.
- Different processes in farming can be done using a single equipment
- It is a one-time investment process.
- This method is efficient for long term profits.
- Health of the farmer won't be damaged.
- An unskilled person can operate the entire process easily.



- Water can be conserved by using this irrigation technique
- Work burden on the farmer is reduced

## **7. CONCLUSION**

- The main theme of this project is to provide an efficient and healthy method for cultivation.
- Our motto is to give good profits to farmers by not harming their lives. A small change in our traditional method can give huge profits and comforts.

## **8. REFERENCES**

- [1] Uwe A. Schneider 2010 Impacts of population growth, economic development, and technical change on global food production and consumption
- [2] M. Margni 2001 Life cycle impact assessment of pesticides on human health and ecosystems
- [3] Quinn Brackett October, 1982 Monorail Technology Study
- [4] D. Yallappa 2017 Development and evaluation of drone mounted sprayer for pesticide applications to crops
- [5] William E. Luecke 2005 Mechanical Properties of Structural Steels