



Driver Assistance System

V A Bala Krishna Jakka, Vishnu Priya Kunapareddy,
Sai Sushmitha Jagga, Akshay Kumar Nonne and
Akhil Sri Sai Vetsa

EasyChair preprints are intended for rapid dissemination of research results and are integrated with the rest of EasyChair.

November 10, 2022

[Type here]

Driver Assistance System

J V A Bala Krishna, K Vishnu Priya, J Sai Sushmitha, N Akshay Kumar,

V Akhil Sri Sai

Vallurupalli Nageswara Rao Vignana Jyothi Institute of Engineering and Technology

Abstract —*Accidents are continually growing with the growing vehicular population. The authorities' task of preventing or reducing deadly traffic accidents has become a nightmare, and their efforts have been in futile. So, our proposed system is to make a system that can detect when a vehicle is being driven erratically, identify the driver's tiredness, and about the vehicle's servicing schedule by transmitting the data to the individual in charge. If the driver is driving erratically, a warning message will be sent to the registered phone number along with the vehicle's geo-location. The proposed system unit will monitor the driver's sleepy behavior and preserve him undistracted during the trip, and the service reminder will schedule the servicing of the vehicle.*

Keywords -*Raspberry Pi, Global Positioning System, Accelerometer, Analog and Digital Converter.*

I. INTRODUCTION

The term 'automotive IoT' refers to embedding IoT technologies into automotive systems create to form new applications and solutions which may make vehicles smarter and additional intelligent, facilitating safe, economical and cozy driving. The absence of novel options in vehicles is one in every of the explanations why the automotive trade has been unable to interrupt its annual production and sales records. In today's market, consumers hunt for over four tyres and a handwheel in an exceedingly vehicle. they're trying to find an art movement vehicle with that to speak and connect.

The Internet of Things (IoT) has given carmakers and consumers everywhere the globe new choices. IoT within the automobile sector has become a hotspot for a spread of multi-purpose applications, with use at each the commercial level. IoT applications within the automotive trade square measure increasing day by day. With the improvement within the technology of web of Things, additional refined automobile use cases can crop up that may fully modification the manner within which we have a tendency to move with our vehicles.

The IoT in vehicles can deliver a quicker, safer and richer expertise for drivers. it's currently doable for drivers to access data concerning traffic, road conditions, fuel usage, vehicle medicine, driving behavior and additional. And vehicle IoT is increasing in importance. The technical school remains evolving, connected cars square measure simplifying life for each driver and makers, particularly once it involves electronic upgrades. IOT primarily based Driver & vehicle assistant system entails the management of motorcars like cars, vans, and trucks, among different things. Firms that think about transportation in their business will use this to cut back the risks related to enhancing transportation potency, safety, and productivity whereas additionally lowering total transportation and workers expenses.

The subsequent area unit some of the attributes:

- Safety of the driving force to reduce risk and improve safety measures, monitor driving sleepiness behaviors on the road.
- Analytics and Vehicle Tracking To observance and analyzing crucial metrics for optimum performance victimization fleet management computer code or manual techniques.
- Savings Trying to work out the way to hamper on non-preventative maintenance, hamper on gas prices, and keep prices in check.

Internet of Things beside different riotous technologies is revolutionizing the entire automotive trade. Evolution during this field has brought within the emergence of trailblazing development in cars in terms of connected and automatic cars. Its usage has revamped automobile examination and maintenance capabilities and conferred new mediums of diversion. Moreover, conveyance telematics is permitting long-range knowledge transmission that has helped within the emergence of associate IoT high-powered fleet management.

II. LITERATURE SURVEY

The system which is able to detect driver drowsiness level using image processing and OpenCV

[Type here]

technique that calculates and measures Eye Aspect Ratio (EAR), in other words size of the driver's eye. The data of EAR has to be gathered to determine the threshold value that indicates whenever a driver is experiencing drowsiness. So, when the driver closes his eye based, the EAR reduces over the threshold value, then the program concludes that the driver is drowsy and displays it on the screen or sends to the message to the owner that the driver is drowsy [1].

The creator has proposed this to encourage student to use public transportation provided to commute from one place to another around campus area by providing real time bus information such as bus location and bus arrival time which can be accessed through a web application. Thus, based on result, real-time location of the bus can be tracked and arrival time of the bus to the next bus stop can be estimated. A web application is made to assist users on the bus information The web application is only available to registered users. Unregistered user will not be able to view the map and navigate through the web application. First time user has to register his/her username and password. Unregistered user will get notified once the user tries to log in with fake username and password.

In order to assist users in navigating around campus using university bus, bus routes and bus stop's locations data are collected and plotted onto a Google Map. Location data consists of latitude, longitude of the bus stops. All bus stops are labelled with number for identification in further processes [2].

The main reason behind the accidents is the carelessness and reckless driving of the drivers. In this paper, an IoT based system is proposed to ensure the continuous monitoring of the parameters of a running vehicle like vehicle speed, number of hard brakes, and rolling of the vehicle, which can be a measure of the 'quality of driving'. The parameters will be uploaded to a server every instant so that the bus authority can directly observe the driver's performance, which will increase the responsibility of the driver to avoid reckless driving.

Whenever the vehicle speed exceeds the safe calculated threshold speed, the system will alert the driver by playing sound on the buzzer. Besides, the system has also a button. In case of an accident, if this button is pressed, the system will send SMS instantly to proper authority with the location information. In this way, this system can speed up the rescue operation, minimize the casualties after the accident, and numerous important human lives can be spared [3].

III. PROPOSED SOLUTION

A. Technical Background

In order to avoid situations like accidents and poor utilization of resources available, drivers/owners or the companies need an indispensable and influential tool to grant cost-effective along with productive operations, from accurate vehicle tracing to driver behavior. Until now, there is no device with multiple attributes such as rash driving detection, driver's drowsiness detection, vehicle's geo-location and service or maintenance alert.

B. Proposed System

IOT based driver assistance system to mitigate the risks involved with improving traffic performance, protection, and productivity while also cutting total

transportation and staff costs. The main objective of the project is to develop a system that enables the driver to remain un-distracted fully alert throughout the drive and also notify the owner on dangerous vehicle rash driving. A managing system to be developed that continuously monitors the driver's drowsiness behavior, rash driving alert along with geolocation and service alert of the vehicle.

To create a system that enables the driver of the vehicle or also the owner of the commercial vehicle organization to know: -

- 1.Driver's drowsiness behavior
- 2.Rash Driving Alert
- 3.Service or Maintenance Alert
4. Vehicle Geo-location

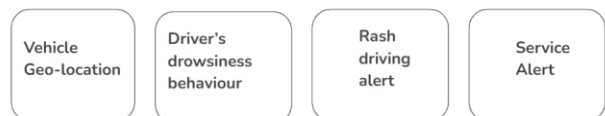

Fig. 1. Driver Assistance System

IV. HARDWARE COMPONENTS

A. Raspberry Pi 3 Model B

Raspberry Pi is a tiny single board computer. By connecting peripherals like Keyboard, mouse, show to the Raspberry Pi, it'll act as a mini notebook computer. it's popularly used for real time Image/Video process, IoT primarily based applications and AI applications. it's slower than laptop or

[Type here]

desktop however continues to be a computer which may offer all the expected options or talents, at an occasional power consumption. Raspberry Pi Foundation formally provides Debian primarily based Raspbian OS. Also, they supply NOOBS OS for Raspberry Pi. we are able to install many Third-Party versions of OS like Ubuntu, Arch Linux, RISC OS, Windows 10 IOT Core, etc.

The hardware speed of Raspberry Pi varies from 700 MHz to 1.2 GHz. Also, it's on-board SDRAM that ranges from 256 MB to 1 GB. It conjointly provides on-chip SPI, I2C, I2S and UART modules.



Fig. 2. Raspberry pi

B. Web Camera

A webcam may be a video camera that feeds or streams a picture or video in real time to or through a laptop to a network. Webcams are usually tiny cameras that sit on a table, attach to a user's monitor. Webcams are often used throughout a video chat session involving 2 or a lot of folks, with conversations that embody live audio and video. Web camera software system permits users to record a video or stream the video on the internet. As video streaming over the web needs abundant information measure, such streams typically use compressed formats. the most resolution of a web camera is additionally below most hand-held video cameras, as higher resolutions would be reduced throughout transmission. The lower resolution permits webcams to be comparatively cheap compared to most video cameras, however the impact is adequate for video chat sessions.



Fig. 3. Web camera

C. GPS Module

Global Positioning System (GPS) is a navigation system supported satellite. It creates the revolution in navigation and position location. it's chiefly utilized in positioning, navigation, observation and measurement applications. the

most important benefits of satellite navigation square measure real time positioning and time synchronization. GPS is created of 3 totally different elements, that employment along to produce location info.

The 3 segments of GPS are:

- Space (Satellites) — The satellites circling the planet, sending signals to users on geographical position and time of day.
- Ground management — The management section is created of Earth-based monitor stations, master management stations and ground antenna. management activities embrace tracking and operating the satellites in space and observe transmissions.
- User equipment — GPS receivers and transmitters together with things like watches, smartphones and telematic devices.

There are five main uses of GPS:

1. Location — determining position.
2. Navigation — obtaining from one location to a different.
3. Tracking — watching object or personal movement.
4. Mapping — making maps of the globe.
5. Timing — creating it potential to require precise time measurements.



Fig. 4. GPS Neo6M

D. Accelerometer

Accelerometer is a chip-based technology where sensors are composed of a suspended mass between a combine of electrical phenomenon plates. Once the sensing element is tilt, a distinction in electrical potential is made by this suspended mass. The created distinction is then measured as a modification in capacitance. MEMS are microscopic integrated devices that are a mix of electronics, electrical and mechanical parts, all operating along for one useful demand employing a technology referred to as Microsystems Technology (MST). The size of MEMS is typically within the order of few micrometers (between one to a hundred micrometers).

[Type here]

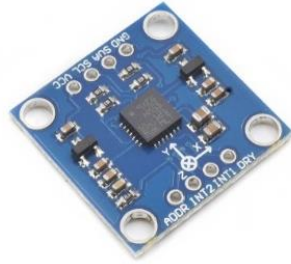

Fig. 5. Accelerometer

E. Analog to Digital Converter

An ADC is a device that converts analog signals into digital signals. The analog signal is a continuous sine wave that cannot be read by a computer, hence the need of conversion. By converting the analog signal, data can be amplified, added or taken from the original signal. The sample rate of an ADC is that how fast an ADC can convert the signal from analog to digital. Bit resolution is nothing but how much accuracy can an analog to digital converter can convert the signal.

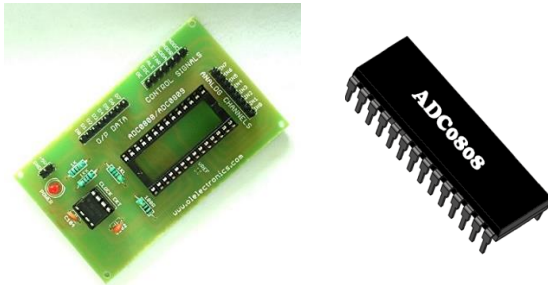

Fig. 6. ADC

F. Buzzer

There are some ways to speak between the user and a product. one among the simplest ways that is audio communication employing a buzzer IC.

An audio device sort of a pager or buzzer could also be electromechanical device or piezoelectric or mechanical sort. the operation of this is often to convert the signal from audio to sound. Generally, it's powered through DC voltage and employed in timers, alarm devices, printers, alarms, computers, etc. Based on the assorted styles, it will generate completely different sounds like alarm, music, bell & siren.

The pin configuration of the buzzer includes 2 pins particularly positive and negative. The positive terminal of this is often denoted with the '+' sign or long terminal. This terminal is powered through 6Volts whereas the negative terminal is delineated with the '-' symbol or short terminal and it's connected to the GND terminal.



Fig. 7. Buzzer

B. Software Requirements

1. IDE (Python)
 - a. Open CV
 - b. Dlib
 - c. Scipy
 - d. Twilio
 - e. RPI GPIO
 - f. Serial
3. Raspbian OS

V. METHODOLOGY

A. Block Diagram

Figure. 1, shows the block diagram of our solution to detect rash driving, driver's behavior, vehicle's Geo location and service alert. The system consists of accelerometer, Raspberry pi 3, camera, GPS modules and an alarm.

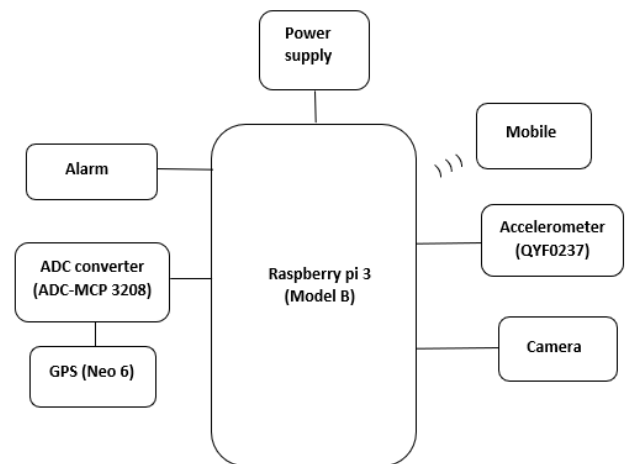

Fig. 8. Block Diagram of the proposed system

The raspberry pi 3b model used here holds the required

[Type here]

into the cascade classifier. CNN Classifier will categorize whether eyes are open or closed. Calculate score to check whether the driver is drowsy. If the driver is detected to be drowsy the alarm gets activated.

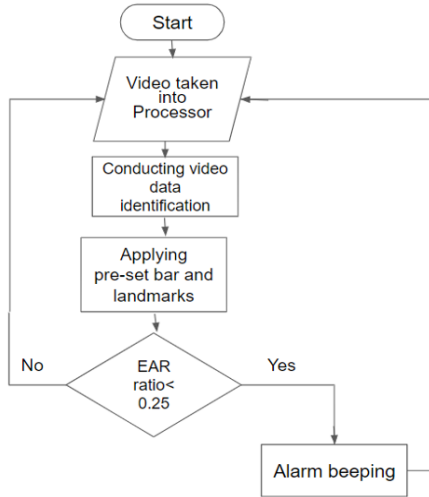

Fig. 12. Flow chart of driver drowsiness system

3. Service Alert

The system has to give the alert through SMS about the maintenance of the vehicle after desired time. A counter program in python IDE is initiated and define SMS function, we import Twilio modules and add the token I'd and Twilio number along with the phone number of the owner to whom we need to send the message.

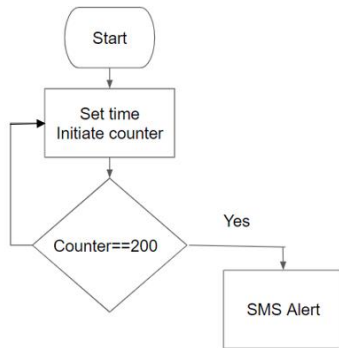

Fig. 13. Flow chart of service alert

4. Vehicle Geo-location

The system as to detect location of vehicle using GPS Neo M6 module and providing a hyper link to show the location in Google maps. Whenever the face is detected, extraction of data from GPS module is retrieved with location coordinates in latitude and longitude format. As well as hyperlink is provided in the console window for accessing exact location.

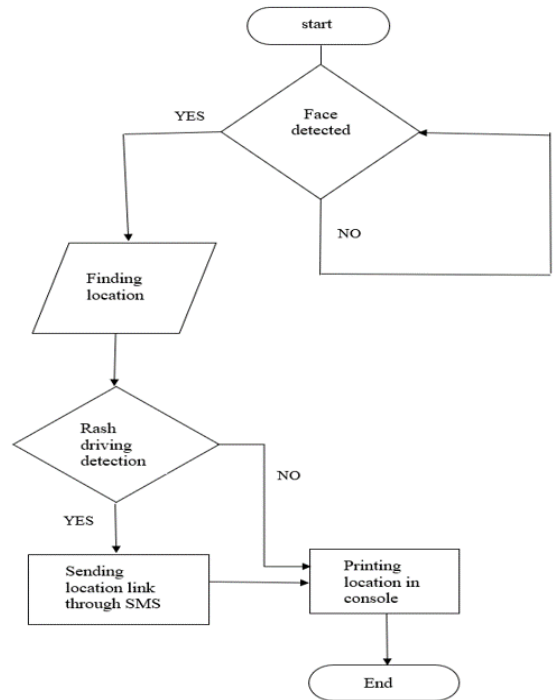

Fig. 14. Flow chart of geo-location

VII. RESULTS

The design module has been tested several times. Whenever the system was driven at rash conditions (titling the mems sensor) it sent a message the connected mobile phone along with location co-ordinates.

The webcam/camera can be installed in front of the driver in a car to make the system work properly. For the prototype purpose we have tested the design and camera in all possible ways. The service/maintenance alert is also tested and the results are recorded as shown below:

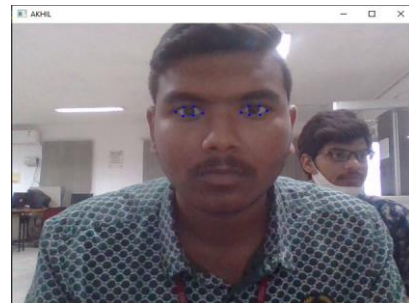

Fig. 15. Not drowsy

[Type here]



Fig. 16. Drowsy

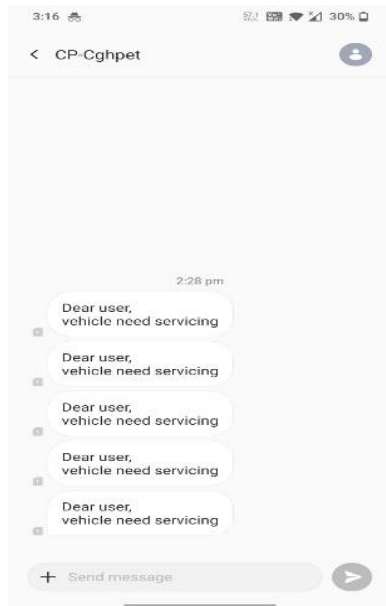

Fig. 17. Service alert notification

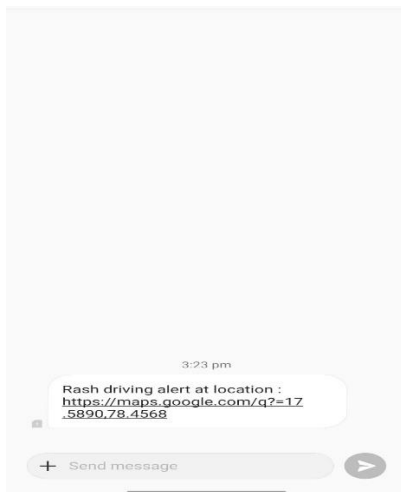

Fig. 18. Rash driving notification

VIII. CONCLUSION

IoT based driver assistance system will offer the tracing, protection, and on-line tracking in one gadget. We proposed IOT Based Driver assistance system that will

provide the tracking security and monitoring for health of vehicle and safety of driver in a single system. This system is very useful to taxicabs companies due to its security features and it also useful for firms like School Bus monitoring, cargo carrying trucks etc.

This proposed project is a tracking, cautioning and predicting tool that will help the driver's and also organisational owners to enable their business/commercial vehicles to reduce costs, improve efficiency and ensure compliance across an entire fleet operation.

IX. FUTURE SCOPE

It can be used in vehicle renting companies, Insurance providers, Schools and college buses, Private travelling agencies. This system can be upgraded for live video streaming in public busses by using 3G/4G enabled modem. Can also add features like SOS button or an emergency button.

More features can be added to the system that may improve the overall driving

Experience and increase the efficiency of the vehicle.

Some of the features that can be added are:

- 1.Mileage management
- 2.Automatic drive modes
- 3.live vehicle footage
- 4.Driver safety monitoring
- 5.Collecting different stats for analytics

X. ACKNOWLEDGEMENT

We would like to thank our professor J.V.A Bala Krishna for providing us this opportunity to work under his guidance on a real life problem, the Head of the Department Dr.S Rajendra Prasad and the management of Vnr Vignana jyothi institute of engineering and technology - for providing the necessary facilities, the other professors of electronics and communication Department who has been encouraging us from the beginning till the completion of our project, and all the faculties and lab assistants for their help whenever required. Finally, we would like to thank our friends and family members who provided us their valuable inputs and support.

REFERENCES

- [1] Sanjay S, N. Banupriya, Sathish M; Driver Drowsiness system using OpenCV; Second International Conference on Electronics and Sustainable Communication Systems (ICESC), 2021 10.1109/ICESC51422.2021.9532758

[Type here]

- [2] S.A. Saad, A.A.B. Hisham, M.H. Ishak, M.H. Fauzi, M.A. Baharudin and N.H. Idris, "Real-time on-campus public transportation monitoring system"; 2018 IEEE 14th International Colloquium on Signal Processing and Its Applications (CSPA), pp. 215-220, 2018.
- [3] Mohammed Abdul Kader; Md. Eftekhari Alam; Sabrina Momtaj; Saidun Necha; Mohammed Shamsul Alam; Abdul Kadar Muhammed Masum; IoT Based Vehicle Monitoring with Accident Detection and Rescue System; 2019 22nd International Conference on Computer and Information Technology (ICIT) 10.1109/ICIT48885.2019.9038600.
- [4] A. Malla, P. Davidson, P. Bones, R. Green and R. Jones, "Automated Video-based Measurement of Eye Closure for Detecting Behavioral Microsleep"; in 32nd Annual International Conference of the IEEE, Buenos Aires, Argentina, 2010
- [5] M. Dey, M.A. Arif and M.A. Mahmud, "Anti-theft protection of vehicle by GSM and GPS with fingerprint verification"; 2017 International Conference on Electrical Computer and Communication Engineering (ECCE), pp. 916-920, 2017.
- [6] P. Zhang, Z. Shi and M. Xu, "Design and implementation of vehicle monitoring system based on GPRS"; 2005 International Conference on Machine Learning and Cybernetics, vol. 6, pp. 3574-3578, 2005.
- [7] Singh, P., Juneja, N., Kapoor, S. "Mobile phone sensors to detect driving behavior", Proceedings of the 3rd ACM Symposium on Computing for Development, 2013.
- [8] Mandal, Bappaditya; Li, Liyuan; Wang, Gang Sam; Lin, Jie (2016). Towards Detection of Bus Driver Fatigue Based on Robust Visual Analysis of Eye State. IEEE Transactions on Intelligent Transportation Systems. pp.1-13. 10.1109/TITS.2016.2582900 .
- [9] Gope, Prosanta; Hwang, Tzonelih (2015). BSN-Care: A Secure IoT-based Modern Healthcare System Using Body Sensor Network. IEEE Sensors Journal, pp. 1-1. doi:10.1109/JSEN.2015.2502401
- [10] Chowdhury, Anuva; Shankaran, Rajan; Kavakli, Manolya; Haque, Md. Mokammel (2018). Sensor Applications and Physiological Features in Drivers' Drowsiness Detection: A Review. IEEE Sensors Journal, pp.1-1 doi:10.1109/JSEN.2018.2807245.
- [11] Padmaja, B; Narasimha Rao, P V; Madhu Bala, M; Rao Patro, E Krishna (2018). [IEEE 2018 2nd International Conference on I-SMAC (IoT in Social, Mobile, Analytics and Cloud) (I-SMAC) - A Novel Design of Autonomous Cars using IoT and Visual Features. pp.18-21. doi:10.1109/I-SMAC.2018.8653736
- [12] Shah, Shivang; Abhishek, Parimal; Shrivastava, Deep; Ponraj, Abraham Sudharson (2019). [IEEE 2019 International Conference on Vision Towards Emerging Trends in Communication and Networking (ViTECoN) - Vehicle Service Management and Live Monitoring with Predictive Maintenance System. pp.1-8. doi:10.1109/ViTECoN.2019.8899668.